

TOZOO®

mod.

XX.5Q

Design by *Andrea Frisen*
PRODUCT SPECIFICATIONS

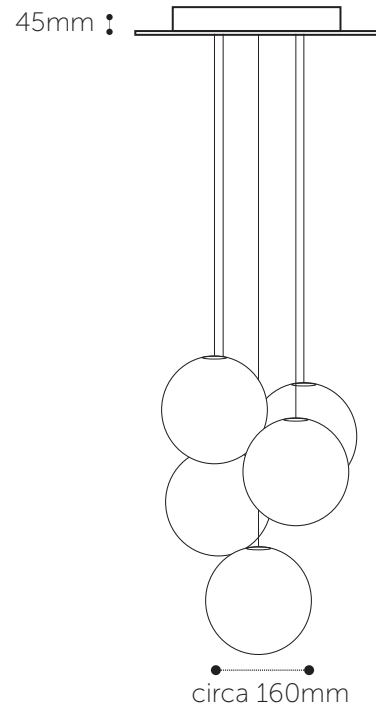

standard length from
550mm

custom length
up to 8000mm

circa 160mm

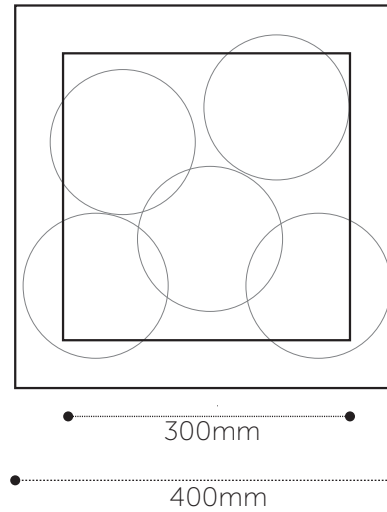

300mm

400mm

PENDANTS: five

LAMPING: G9 - 18w XENON o 3w LED

WEIGHT: approximately 10kg

CABLE: 2x0,75 AWG20

MATERIALS: blown glass, electrical
components, white powder coated canopy

APPLICATIONS:

Suitable for residential or commercial use.

The TOZOO® spheres can be used as suspensions above tables, in homes intended for private use or in restaurants, as luminous accessories for living rooms, or in large compositions for entrances or public spaces.

For more information:

TOZOO®

hello@tozoo.it
www.tozoo.it

© 2014, Oball.due Murano. All rights reserved. All drawings and information
contained may not be reproducible.

1- Remove the plate C from the canopy B

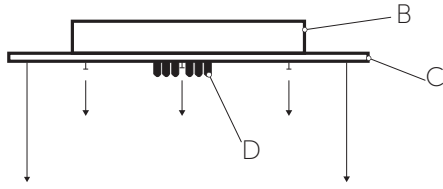

If the caps D have come off the canopy B, put them back on.



2- Remove the bracket A from the canopy B and fix it to the ceiling with suitable screws. In case of a plasterboard ceiling, check the capacity of the latter

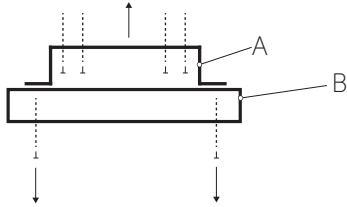

3- Connect the electrical cables, using the special insulating terminal E.

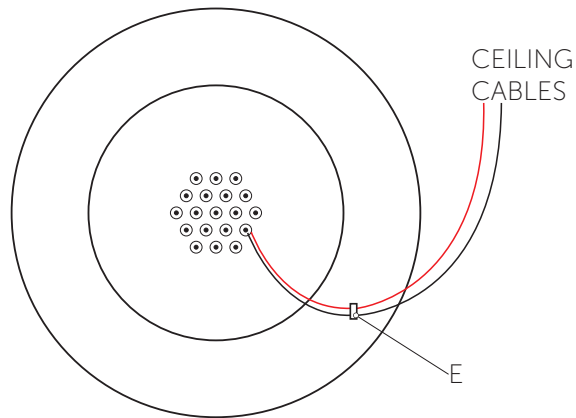

4- Fix the canopy B to the bracket A with the appropriate screws.

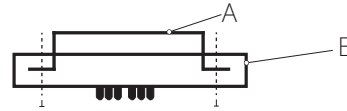

5- Fix the plate C to the canopy B using the appropriate Allen screws and remove the caps D.

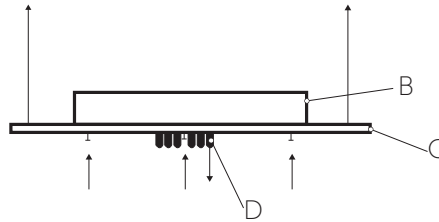

7- Connect the clips G from the canopy to the clips H of the cables of each individual pendant. Proceed from the center outwards.

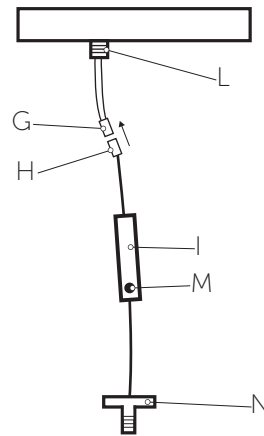

Screw the tube I to the threaded rod L. Finally tighten the Allen screw M in the tube I in order to lock the electric cable.

8- Insert the bulbs into the socket-outlets embedded in the support N.

9- Screw the spheres into support N, proceeding from the center outwards

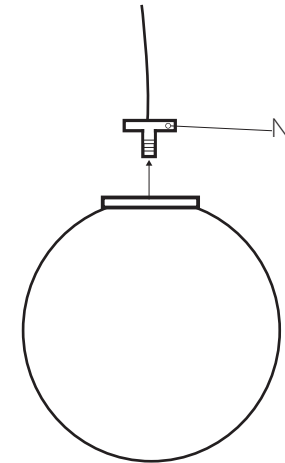

ASSEMBLY TOOLS:

- Screwdriver / Drill
- Screwdriver
- Allen keys

It is advisable to proceed with the assembly of the chandelier in two people.

LAMP HOLDER: G9

LIGHT SOURCE: halogen g9 max 20w
led g9

Per ulteriori informazioni:

TOZOO®

hello@tozoo.it
www.tozoo.it